

## 9.9 Installation

### 7.9.1 Safety

- This manual should always be accessible and close to this air condition equipment.
- There are two types of indications, "⚠ WARNING" and "⚠ CAUTION". The indication preventing from death or heavy injury is listed as "⚠ WARNING". Even the indication listed as "⚠ CAUTION" may also cause serious accident. Both of them are related to safety, and should be strictly followed.
- After installation and start-up commissioning, please handover the manual to the user. The manual should be well kept in safe place and close to the unit.

#### ⚠ Warning

















- The installation or the maintenance should be performed by an authorized agency. The wrong operation of this air condition equipment may cause water leakage, electric shock or fire.
- Please install the unit on the top of a solid foundation or structure which is strong enough to support the unit.
- The installation of this condition equipment should follow local construction codes.
- Use the right cable size, secure the terminal firmly, organize the cables well and make sure no tension is added on cables. Cable insulation should not be damaged. The incorrect installation may lead to overheat or fire.
- When installing or moving the unit, the refrigerant system should be vacuumed and recharged with R-410A refrigerant. If any other gas enters the system, it may lead to abnormal high pressure which may cause damage or injury.
- Please use the proper manifolds or branches during the system installation. The wrong parts may cause refrigerant leakage.
- Keep the drain pipe away from toxic gas vents to prevent possible pollution of indoor environment.
- During or after the installation, please check whether there is refrigerant leakage. If any leakage, please take any measures for ventilation. The refrigerant may be toxic at some concentration levels.
- The unit is not explosion-proof. Please keep it away from flammable gases.
- The drain pipe should be installed per this manual to ensure proper drainage. The pipe should be well insulated to avoid condensation. Wrong installation may lead to water leakage.
- Both liquid pipe and the gas pipe should be also well insulated. Not enough insulation may lead to system performance deterioration or humidity formation.
- This air condition equipment is not intended to be operated by persons with lack of experience and training, unless they have supervision or instruction concerning use of this air condition equipment.
- Please keep children away from this air condition equipment.
- If the supply cord is damaged, it must be replaced by the manufacturer, its service agent or similarly qualified persons in order to avoid a hazard.
- This appliance is not intended for use by persons (including children) with reduced physical, sensory or mental capabilities, or lack of experience and knowledge, unless they have been given supervision or instruction concerning use of the appliance by a person responsible for their safety.
- Children should be supervised to ensure that they do not play with the appliance.
- This appliance can be used by children aged from 8 years and above and persons with reduced physical, sensory or mental capabilities or lack of experience and knowledge if they have been given supervision or instruction concerning use of the appliance in a safe way and understand the hazards involved. Children shall not play with the appliance. Cleaning and user maintenance shall not be made by children without supervision.
- The appliances are not intended to be operated by means of an external timer or separate remote-control system.
- Keep the appliance and its cord out of reach of children less than 8 years.

#### ⚠ Attention

- Grounding wire should be connected with the grounding bar. The grounding wire can not be connected to the gas pipe, water pipe, lightning rod or the telephone grounding wire. Improper grounding may cause electric shock.
- The Circuit Breaker should be installed. If not, it may cause electric shocks.
- After installation, the air condition equipment should be powered on and passed the electric leakage current test.

## ⚠ Attention

### Notices during Operation

- Do not put any heating apparatus under the indoor units. The heat may cause distortion of the units.
- Pay attention to the ventilation to avoid anoxic injury.  
- Do not put burning apparatus in the place which the unit blows directly. There is risk of fire or anoxic injury.  
- Ensure the installation area does not deteriorate with age. If the base collapses, the unit may fall and cause damage, product failure, personal injury or death. 
- Do not use the unit for special purposes such as preserving foods, works of art etc. It is an air conditioner for comfort cooling / heating, not a precision refrigeration system. 
- Use the correctly rated breaker or fuse. Improper breaker or fuse may lead to fire, electric shock, explosion, personal injury or death. 
- Do not permit water or steam to enter the unit and the wired controller. There is risk of unit failure, fire, electric shock, personal injury or death. 
- Turn on the power at least 6 hours before operation begins. Starting operation immediately after power on can result in severe damage to internal parts.
- Turn off the power to save energy if the unit will be not used for a long period. If the unit is not powered off, it will consume power.
- 3-minutes protection  
To protect the unit, compressor can be actuated with at least 3-minutes delay after stopping.
- Close the window to avoid outdoor air getting in. Curtains or window shutters can be put down to avoid the sunshine. 
- Do not touch the power switch with the wet hand to avoid power shock. 
- Stop running and switch off the manual power switch when cleaning the unit. 
- During the unit operation, don't switch off the manual power switch. 
- Do not press the liquid crystal zone of controller to prevent damage. 
- Do not clean the unit with water spray. There is risk of unit failure, fire, electric shock, personal injury or death.  
- Keep flammable gas or combustibles away from the unit. There is risk of product failure, fire, personal injury or death. 
- The unit is not intended to be operated by persons with lack of experience and training, unless they have supervision or instruction concerning use of this air condition equipment.
- Please keep children away from this air condition equipment.

## 7.9.2 Maintenance

Clean the air cleaner & air inlet grid.

- Don't dismantle the air cleaner if not cleaning, or faults might be caused.
- When the air conditioner operates in the environment with too much dust, clean the air conditioner more times (generally once every two weeks).

### Cleaning the air outlet port and the shell:

 Attention

- Don't use gasoline, benzene, diluents, polishing powder or liquid insecticide to clean them.
- Do not clean them with hot water of above 50°C to avoid fading or distorting.
- Wipe them with soft dry cloth.
- Water or neutral dry cleanser is recommended if the dust cannot be removed.
- The Wind Deflector can be dismantled to clean (as below).

### Cleaning Wind Deflector:

- Do not wipe the wind deflector with water forcibly to avoid falling off.

### Cleaning Air Cleaner:

 Attention

- Don't rinse the air cleaner with hot water of above 50°C to avoid fading and distorting.
- Don't put the air cleaner on the fire to dry to avoid catching fire.

- Wipe dust with water or dust collector.
- (A) Wipe dust with dust collector.



- (B) Clean it with soft brush in mild detergent
- if there is too much dust on it

- (C) Throw off the water and airing it in the cool dry condition.



### Maintenance before and after Operating Season

Before Operating Season:

1. Please make the following checkup. If abnormal condition occurs, consult the after-service personnel.
  - There is no blockage in inlet port and outlet port of outdoor and indoor units.
  - The ground line and the wiring are in the proper state
2. After cleaning, the air cleaner must be mounted.
3. Switch on to the power.

After Operating Season:

1. In sunny days, blowing operation can be performed for half a day to make the inside of machine dry.
2. Electrical power should be cut down to economize electricity, or the machine will still consume power. Air cleaner and shell must be mounted after cleaning.

## 7.9.3 Fault Checkup

Please check the following when consigning repair service:

	Symptoms	Reasons
All these are not problems	<ul style="list-style-type: none"> <li>Water flow sound</li> </ul>	Water flow sound can be heard when starting operation, during operation or immediately after stopping operation. When it starts to work for 2-3 minutes, the sound may become louder, which is the flowing sound of refrigerant or the draining sound of condensed water.
	<ul style="list-style-type: none"> <li>Cracking sound</li> </ul>	During operation, the air conditioner may make the cracking sound, which is caused from the temperature changes or the slight dilation of heat exchanger.
	<ul style="list-style-type: none"> <li>Terrible smell in outlet air</li> </ul>	During operation, the air conditioner may make the cracking sound, which is caused from the temperature changes or the slight dilation of heat exchanger.
	<ul style="list-style-type: none"> <li>Flashing operating indicator</li> </ul>	When switching it on again after power failure, turn on the manual power switch and the operating indicator flashes.
	<ul style="list-style-type: none"> <li>Awaiting indication</li> </ul>	It displays the awaiting indication as it fails to perform refrigerating operation while other indoor units are in heating operation. When the operator set it to the refrigerating or heating mode and the operation is opposite to the setting, it displays the awaiting indication.
	<ul style="list-style-type: none"> <li>Sound in shutdown indoor unit or white steam or cold air</li> </ul>	To prevent oil and refrigerant from blocking the shutdown indoor units, refrigerant flows in the short time and make the sounds of refrigerant flowing. Otherwise, when other indoor units perform heating operation, white steam may occur; during refrigerating operation, cold air may appear.
	<ul style="list-style-type: none"> <li>Clicking sound when switching the air condition on</li> </ul>	When the conditioner is powered on, the sound is made due to the resetting of the expansion valve.
Please make another check.	<ul style="list-style-type: none"> <li>Start or stop working automatically</li> </ul>	Check if it is in the state of Timer-ON and Timer-OFF.
	<ul style="list-style-type: none"> <li>Failure to work</li> </ul> 	Check if there is a power failure. Check if the manual power switch is turned off. Check if the supply fuse and breaker are disconnected. Check if the protective unit is working. Check if refrigerating and heating functions are selected simultaneously with the awaiting indication on line control.
	<ul style="list-style-type: none"> <li>Bad cooling &amp; heating effects</li> </ul>	Check if air intake port and air outlet port of outdoor units are blocked. Check if the door and windows are open. Check if the filtering screen of air cleaner is blocked with sludge or dust. Check if the setting of wind quantity is at low wind. Check if the setting of operation is at the Fan Operation state. Check if the temperature setting is proper.

Under the following circumstances, immediately stop the operation, disconnect the manual supply switch and contact the after-service personnel.

- When buttons are inflexible actuated;
- When there are foreign objects and water in the refrigerator;
- When it cannot still be operated after removing the operation of protective unit;
- When other abnormal conditions occur.

AD052MSERA(D)    AD072MSERA(D)    AD092MSERA (D)    AD122MSERA(D)  
 AD162MSERA(D)    AD182MSERA (D)    AD242MSERA(D)

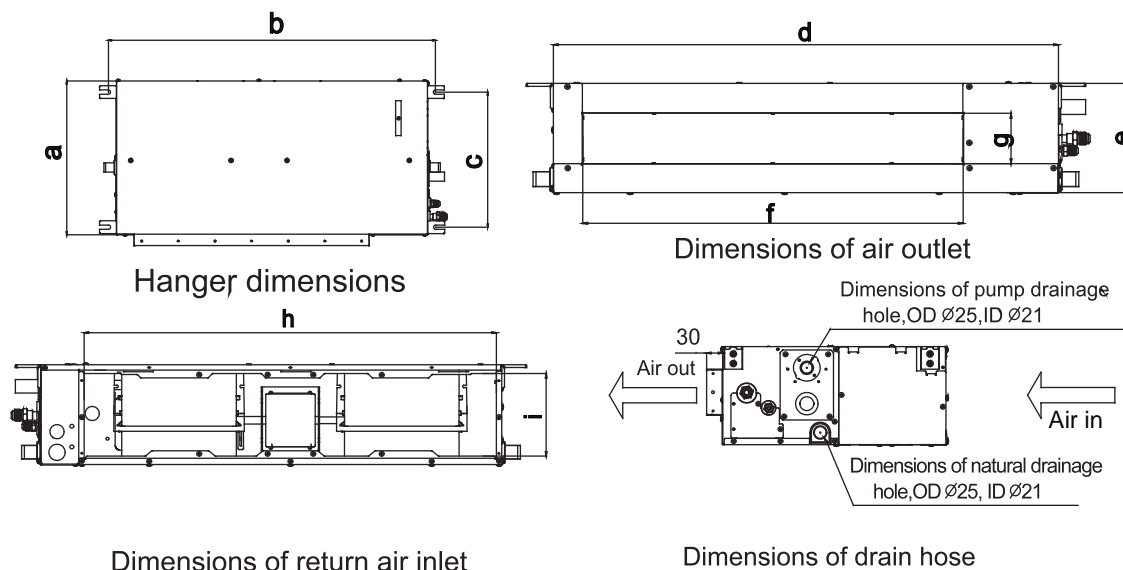

### Installation modes of Indoor unit

This series of air conditioners can be arranged in two air return modes: 1. backward air return (factory default); 2. downward air return (can be adjusted on site. See the following figures.)

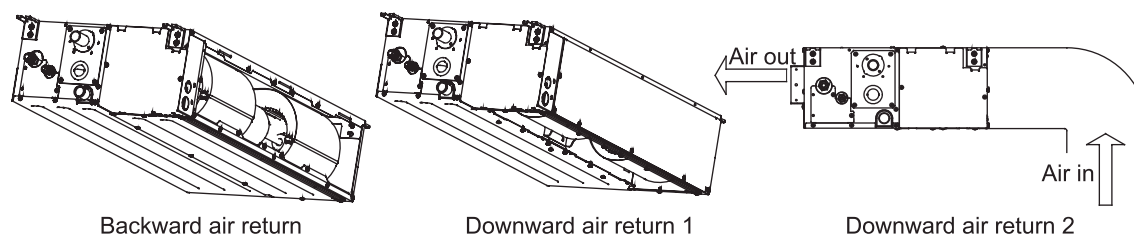

**Note:** the downward air return mode would increase noise 3-5dB(A). It is recommended to install the air conditioner in downward return air mode 2 if enough space is available.

### Installation space and method

#### Body installation

1. Use M10 lifting bolts.
2. Ceiling removal: For different building structures, please consult with indoor decoration personnel about actual conditions.
  - a. Ceiling reinforcement: To ensure the ceiling is horizontal and will not shake, the ceiling base frame must be reinforced.
  - b. Cut off and remove the ceiling base frame.
  - c. Reinforce the end faces left when the ceiling is removed and further reinforce the base frame that fix both ends of the ceiling.
  - d. After the body installation is complete, it is time to install pipes and wires. Before installation, choose a suitable installation position and determine the outgoing direction of pipes. Especially in case that a ceiling exists, please pull refrigerant tubing, drain hose, indoor and outdoor connecting wires, control wires to their connection positions prior to hanging the machine.

### Installation space:

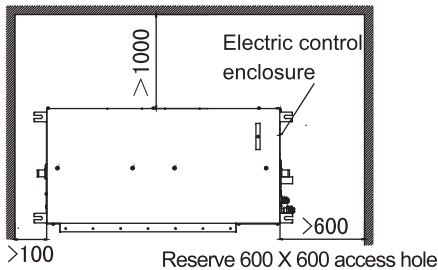

### Installation mode:

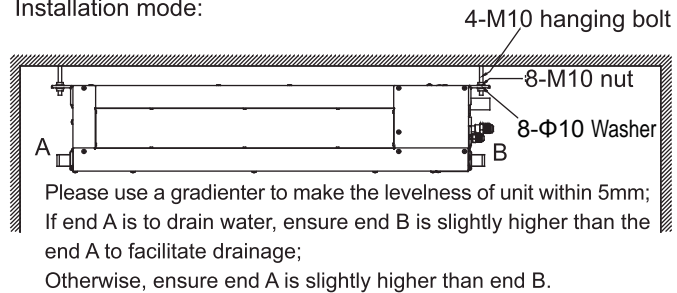

### Installation of air-inlet grille

The angle of air-inlet grille should be parallel with that of air inlet direction, otherwise it will cause more noise. As shown in the figure on the right.

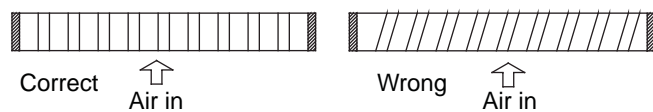

### Installation of Duct Pipe of Indoor Units:

#### 1. Installation of the air blowing pipe:

With a square blast pipe, the bore shouldn't be less than the sizes of air outlet pipe.

2. Installation of the air return pipe: Connect one side of the air return pipes to the air return port of the indoor units with rivets, with the other side connected to air return shutter, as shown in Fig. 1.

3. Heat Preservation of Blast Pipes: Heat preservation lays should be provided for air blowing & return pipes. Paste glue nails on the blast pipes and attach thermo wool, which covered by a layer of silver paper, fix it with glue nail cover, and then seal the joint with silver paper.

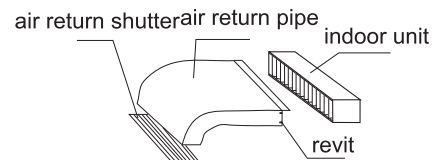

Fig.1  
connection of oil return pipe

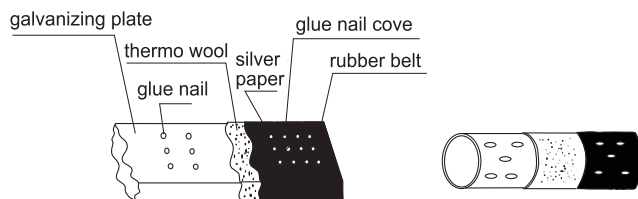

Fig.2

### Selection of fan outlet

This machine uses a DC motor, by which multi-range ESP adjustment is available. The factory default is standard ESP. The ESP & Silent mode can be set according to the pipe resistance and the silence requirement. Setting ranges are as follows:

Model	Ultra-silent	Silent	Standard ESP default	High ESP	Super high ESP
Grade	1	2	3	4	5

### Operation:

When the YR-E17 wired controller is on and the screensaver is off, press the wind speed key & function key together for 5 seconds to get into the ESP adjustment mode. When the grade number is flashing, press "up" and "down" to change, then press the function key to set.

Remote controller: Set temperature of 16°C and press "light" button on remote controller 8 times in 10 seconds, and you hear 2 times beep, then adjusting the temperature to 17 °C, press the button off, then you can hear 1 times beep it means grade 1(Ultra-silent) is set successfully and so on, no action within two minutes, it will automatically exit the function setting.

### Note:

This series are low ESP duct, all the sets above must be handled by YR-E17 or remote controller after asking our after-sales staff according to the installation condition at site. For more details, please see the YR-E17(upgraded) installation instructions.

## Installation of drain hose

### Connection of indoor drain hose

1. Please use accessory drain hose to connect indoor unit's water outlet and PVC pipe and use snap rings to tighten them, as shown in the following figure:
2. Please use rigid PVC adhesive for connection of other pipes and ensure there is no leakage.
3. Drain hose must be wrapped up with insulation sleeve and tightened with strap to prevent air leaked in producing condensate.
4. To prevent water flowing back into air conditioner when the it stops running, drain hose shall decline to the drainage side with a declination of above 1/100. Drain hose expansion or water accumulation shall be prevented, or else it will cause abnormal noise.
5. When connecting the drain hose, do not pull on it so as to avoid the pipe connections getting loose or off. Drain hose should not be pulled out laterally for more than 20cm and should be supported every 0.8-1.0m to avoid bending.
6. The end of drain hose should be more than 50mm away from the ground or the bottom of drainage tank. It should not be put in water. To directly drain condensate into drainage ditch, the drain hose must be U-shaped to avoid stink spreading through the hose into room.

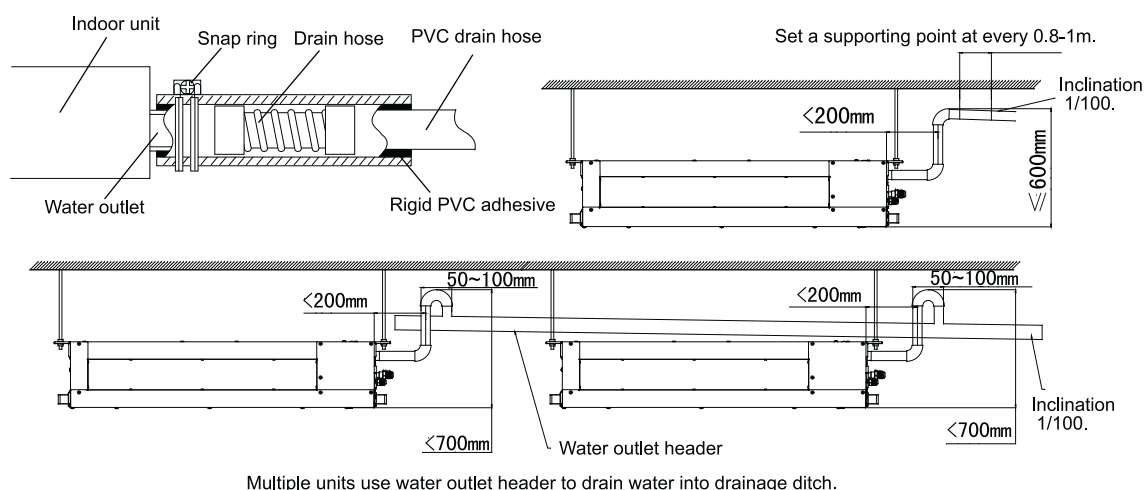

### Drainage test

Before test, firstly ensure the drain hose is unblocked and all connections are tightly sealed and then perform the drainage test as follows:

1. Inject about 500ml water into the water pan through water injection hole;
2. Switch on the power and make air conditioner operate in refrigerating mode. Check whether the water outlet drains water normally and there are no leakages on connections. After the drainage test is complete, replace the water injection hole plug. For the position of water injection hole, see the figure on the right:

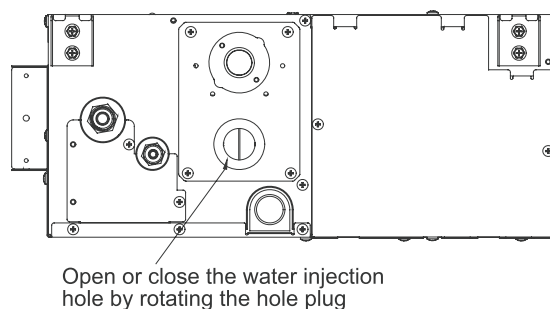

## 7.9.4 Installation Procedures

This manual cannot completely illustrate all the properties of the products you bought. Please contact the local Haier distribution center if you have any question or request.

Please use the standard tools according to the installation requirements.

The standard attached accessories of the units of this series refer to the packing list; prepare other accessories according to the requirements of the local installation point of our company.

**1.Choose the suitable installation location. Indoor units should be installed in places with the environment of even circulation of cool and warm blows. The following places should be avoided.**

Places with high salinity (beach), high sulfured gas(such as the thermal spring regions where copper tubes and soft soldering are easy to be eroded), much oil(including mechanical oil) and steam; places where organic substance solvent is frequently used; places where machines generate the high frequency electromagnetic wave (abnormal condition will appear in the control system); places where there is high humidity exists near the door or windows (dew is easily formed); and places where the special sprayer is frequently used.

### Indoor Units

1. The distance between wind outlet port and the ground should not be more than 2.7m.
2. Select appropriate places for installation where the outlet air can be spread to places all over the house and arrange proper locations for connecting pipes and lines as well as the drainpipe to the outdoor.
3. Ceiling construction must be hard enough to hold the weight of the unit.
4. Make sure that the connecting pipe, the drainpipe and connecting guide line can be put into walls to connect the outdoor units.
5. It is recommended to make the connecting pipe between the outdoor and indoor units and the drainpipe are as short as possible.
6. Please read the attached installation instruction of outdoor units for regulation of filling amount of refrigerant if necessary.
7. The connecting flange should be checked by users.
8. Those electrical appliances such as television, instruments, devices, artwork, piano, wireless equipment and other valuables should not be placed under the indoor unit as to prevent condensate from dropping into them and causing damage.

**2.The following steps can be taken after selecting the installation place:**

- (1) Cut a hole in the wall and insert connection pipe and connecting wires through a locally purchased PVC pipe. The hole should be inclined slightly downward with an inclination of at least 1/100 (see Figure 1).
- (2) Before cutting the hole, ensure no pipe or rebar is placed behind the cutting position. Avoid cutting a hole at the place of wires or connection pipes.
- (3) Hang the unit on a horizontal and firm roof. If the unit base is not stable, it may cause noise, vibration or leakage.
- (4) Support the unit firmly and change the shapes of connection pipe, connecting wires and drain pipe to make them easily get through the hole.

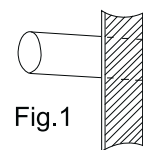

### 3.Dimension (unit: mm).

Model	a	b	c	d	e	f	g	h	i
AD052MSERA(D) AD072MSERA(D) AD092MSERA(D) AD122MSERA(D) AD162MSERA(D)	420	892	370	850	185	640	90	760	152
AD182MSERA(D)AD242MSERA(D)	420	1212	370	1170	185	960	90	1080	152



## Pipe Length & Height Difference

Please refer to the attached manual of outdoor units.

## Tubing Materials & Specifications

Special tools for R410A should be used for cutting and enlarging pipes.

Model		AD072~092 MSERA(D)	AD122~182 MSERA(D)	AD242 MSERA(D)
Tubing Size(mm)	Gas pipe	Ø9.52	Ø12.7	Ø15.88
	Liquid pipe	Ø6.35	Ø6.35	Ø9.52
Tubing Material	Phosphor deoxy bronze seamless pipe (TP <sub>2</sub> ) for air conditioner			

## Refrigerant Recharge Amount

Add the refrigerant according to the installation instruction of outdoor unit. The addition of R410A refrigerant must be performed with a measure gage to ensure the specified amount while compressor failure can be caused by filling too much or little refrigerant.

## Connecting Procedures of Refrigerant Tubing

With the soft solder, the nitrogen-filling protection should be used.

### Cutting and Enlarging

Cutting or enlarging pipes should be proceeded by installation personnel according to the operating criterion if the tube is too long or flare opening is broken.

### Vacuumizing

Vacuumize from the stop valve of outdoor units with vacuum pump. Refrigerant sealed in indoor machine is not allowed to use for vacuumization.

Vacuum pump with check valve should be used for vacuumizing to prevent pump oil flowing into the machine.

### Open All Valves

Open all the valves of outdoor units. [NB: oil balancing stop valve must be shut up completely when only connected one main unit.]

### Checkup for Air Leakage

Check if there is any leakage at the connecting part and bonnet with hydrophone or soapsuds.

## Connecting

### 1. Connecting circular terminals:

The connecting method of circular terminal is shown in the Fig. Take off the screw, connect it to the terminal tier after heading it through the ring at the end of the lead and then tighten it.

### 2. Connecting straight terminals:

The connection methods for the circular terminals are shown as follows: loosen the screw before putting the line terminal into the terminal tier, tighten the screw and confirm it has been clamped by pulling the line gently.

### 3. Pressing connecting line

After connecting line is completed, press the connecting line with clips which should press on the protective sleeve of the connecting line.

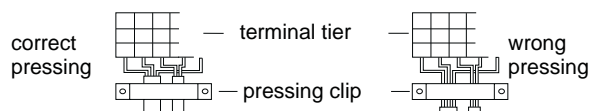

## 7.9.5 Electrical wiring

### ⚠ WARNING

- Electrical construction should be made with specific mains circuit by the qualified personnel according to the installation instruction. Electric shock and fire may be caused if the capacity of power supply is not sufficient.
- During arranging the wiring layout, specified cables should be used as the mains line, which accords with the local regulations on wiring. Connecting and fastening should be performed reliably to avoid the external force of cables from transmitting to the terminals. Improper connection or fastness may lead to burning or fire accidents.
- There must be the ground connection according to the criterion. Unreliable grounding may cause electrical shocks. Do not connect the grounding line to the gas pipe, water pipe, lightning rod and telephone line.

### ⚠ ATTENTION

- Only copper wire can be used. Breaker for electric leakage should be provided, or electric shock may occur.
- The wiring of the mains line is of Y type. The power plug L should be connected to the live wire and plug N connected to null wire while  $\oplus$  should be connected to the ground wire. For the type with auxiliary electrically heating function, the live wire and the null wire should not be misconnected, or the surface of electrical heating body will be electrified. If the power line is damaged, replace it by the professional personnel of the manufacturer or service center.
- The power line of indoor units should be arranged according to the installation instruction of indoor units.
- The electrical wiring should be out of contact with the high-temperature sections of tubing as to avoid melting the insulating layer of cables, which may cause accidents.
- After connected to the terminal tier, the tubing should be curved into be a U-type elbow and fastened with the pressing clip.
- Controller wiring and refrigerant tubing can be arranged and fixed together.
- The machine can't be powered on before electrical operation. Maintenance should be done while the power is shut down.
- Seal the thread hole with heat insulating materials to avoid condensation.
- Signal line and power line are separately independent, which can't share one line. [Note: the power line and signal line are provided by users. Parameters for power lines are shown as below:  $3 \times (1.0-1.5) \text{ mm}^2$ ; parameters for signal line:  $2 \times (0.75-1.25) \text{ mm}^2$  ( shielded line)]
- 5 butt lines (1.5mm) are equipped in the machine before delivery, which are used in connection between the valve box and the electrical system of the machine. The detailed connection is displayed in the circuit diagram.

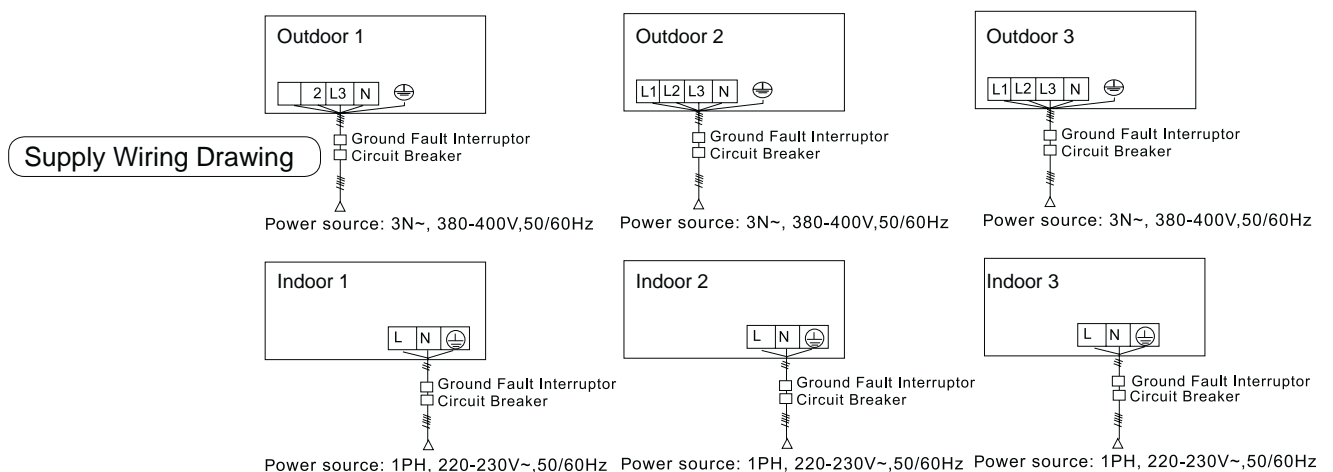

- Indoor units and outdoor units should be connected to the power source separately. Indoor units must share one single electrical source, but its capacity and specifications should be calculated. Indoor & outdoor units should be equipped with the power leakage breaker and the overflow breaker.

## Signal Wiring Drawing

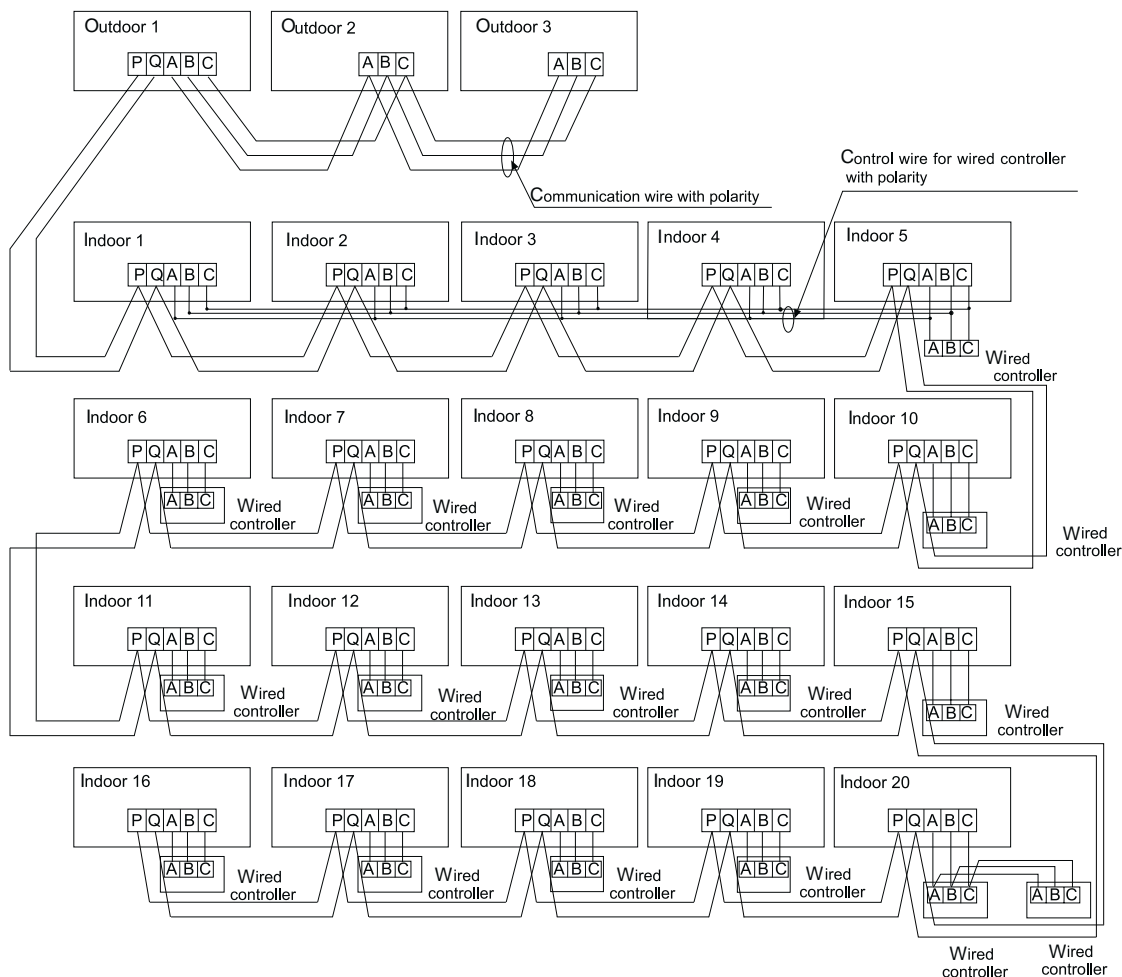

Outdoor units are of parallel connection via three lines with polarity. The master unit, central control and all indoor units are of parallel connection via two lines without polarity.

There are three connecting ways between wired controller and indoor units:

- A. One wired controller controls multiple units, i.e. 2-16 indoor units, as shown in the above figure, (1-5 indoor units). The indoor unit 5 is the wired control master unit and others are the wired control slave units. The remote control and the master unit (directly connected to the indoor unit of wired control) are connected via three lines with polarity. Other indoor units and the master unit are connected via three lines with polarity. SW01 on the master unit of wired control is set to 0 while SW01 on other slave units of wired control are set to 1, 2, 3 and so on in turn. (Please refer to the code setting A at page 28)
- B. One wired controller controls one indoor unit, as shown in the above figure (indoor unit 6-19). The indoor unit and the wired controller are connected via three lines with polarity.
- C. Two wired controller control one indoor unit, as shown in the figure (indoor unit 20). Either of the wired controller can be set to be the master wired controller while the other is set to be the auxiliary wired controller. The master wired controller and indoor units, and the master and auxiliary wired controller are connected via three lines with polarity.

Note: For DC motor slim low ESP duct, the PCB comes with the terminal blocks. Please be sure to pay attention to do the wiring according to the identification. The power lines and signal lines go through the metal wire hole separately with the protective sleeve of the connecting line

Indoor power supply wiring & signal wiring between indoor and outdoor & signal wiring between indoors.

Items Total Current of Indoor Units(A)	Cross Section (mm <sup>2</sup> )	Length (m)	Rated Current of Overflow Breaker(A)	Rated current of residual Circuit Breaker(A) Ground Fault Interruptor(mA) Response time(S)	Cross Sectional Area of Signal Line	
					Outdoor -indoor (mm <sup>2</sup> )	Indoor -indoor (mm <sup>2</sup> )
<7	2.5	20	10	10 A,30 mA,0.1S or below		
≥7 and <11	4	20	16	16 A,30 mA,0.1S or below	2 cores×(0.75-2.0) mm <sup>2</sup> shielded line	
≥11and <16	6	25	20	20 A,30 mA,0.1S or below		
≥16 and <22	8	30	32	32 A,30 mA,0.1S or below		
≥22 and <27	10	40	32	32 A,30 mA,0.1S or below		

- The electrical power line and signal lines must be fastened tightly.
- Every indoor unit must have the ground connection.
- The power line should be enlarged if it exceeds the permissible length.
- Shielded lays of all the indoor and outdoor units should be connected together, with the shielded lay at the side of signal lines of outdoor units grounded at one point.
- It is not permissible if the whole length of signal line exceeds 1000m.

Signal wiring of wired controller

Length of signal line (m)	Wiring dimensions
≤ 250	0.75mm <sup>2</sup> ×3 core shielded line

- ※ The shielding lay of the signal line must be grounded at one end.
- ※ The total length of the signal line shall not be more than 250m.